

KVADRO-100 / KVADRO-125

Bezrámečkové designové talířové ventily

Technická data

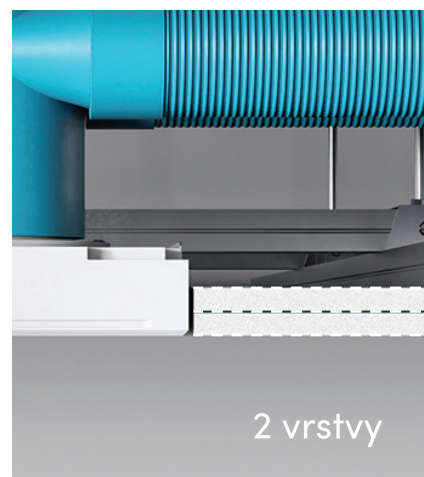
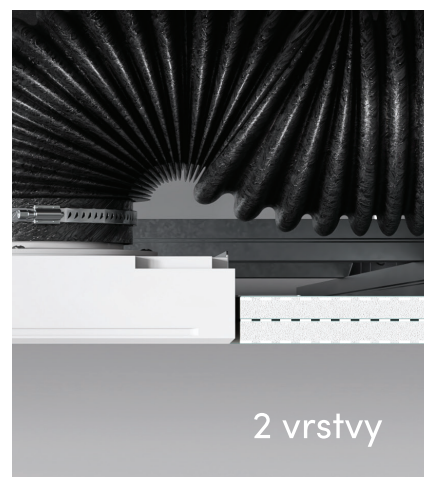
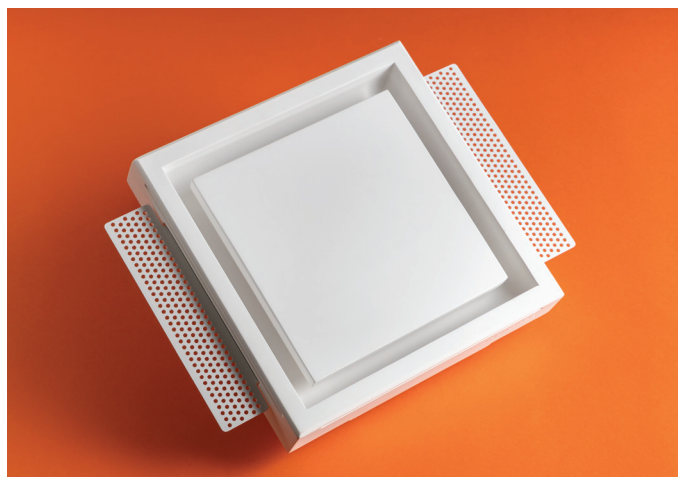
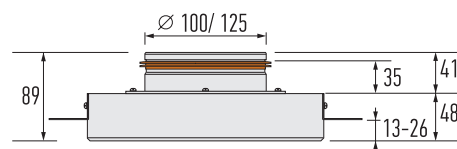
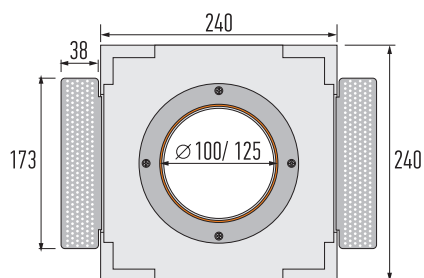
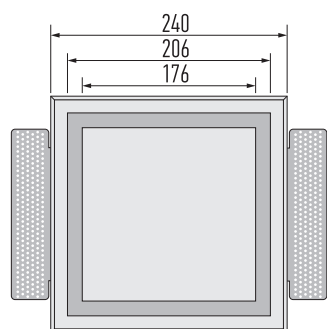

KVADRO-100 / 125

Technická data



frameless
air diffusers

KVADRO 100 (přívod)

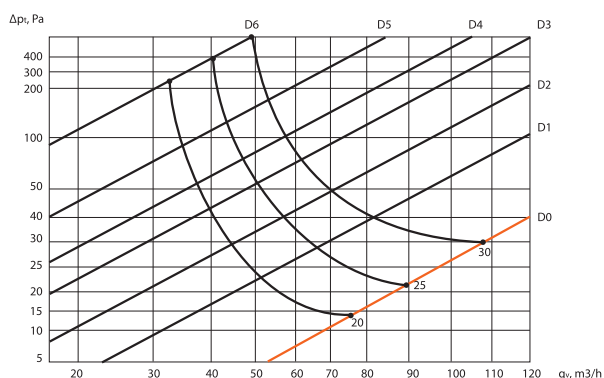

KVADRO 125 (přívod)

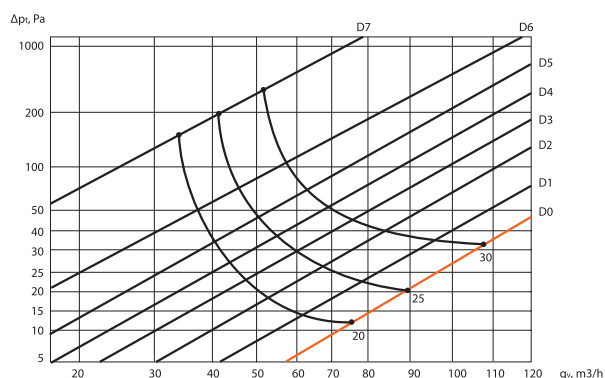

KVADRO 100 (odtah)

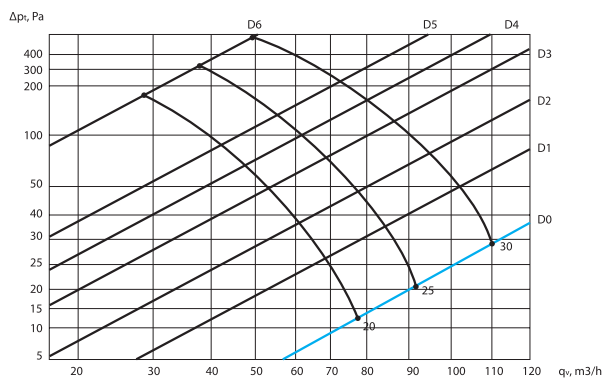

KVADRO 125 (odtah)

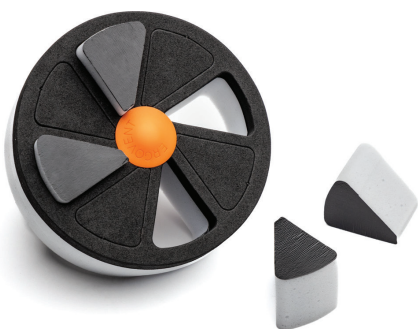
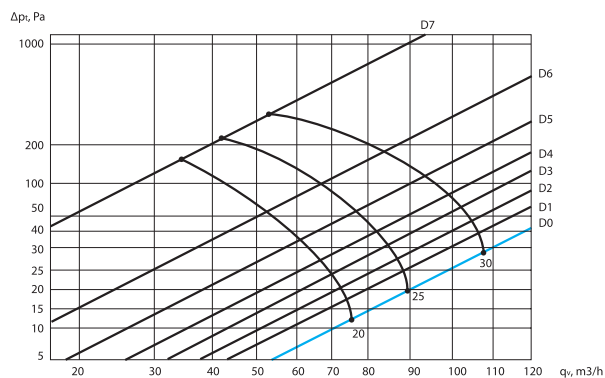

K regulaci průtoku je používána polyuretanová klapka.

- D0 – bez vložené klapky
- D1 – 1 vložený segment
- D2 – 2 vložené segmenty
- D3 – 3 vložené segmenty
- D4 – 4 vložené segmenty
- D5 – 5 vložené segmenty
- D6 – 6 vložené segmenty
- D7 – 7 vložené segmenty

KVADRO 100/125
rychlost, m/s

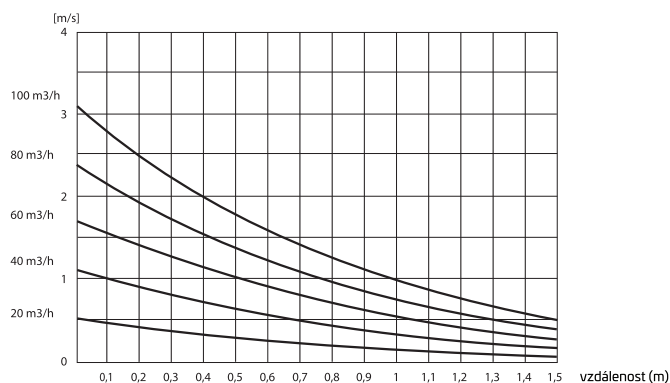

Naskenujte QR kód ke stažení montážního návodu.